

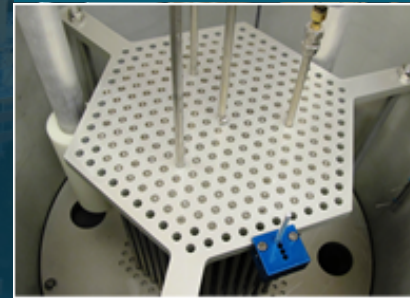

Sandia BUCCX Titanium and Aluminum Sleeve Experiments (IER-45 I)



PRESENTED BY

David Ames



Sandia National Laboratories is a multimission laboratory managed and operated by National Technology and Engineering Solutions of Sandia LLC, a wholly owned subsidiary of Honeywell International Inc. for the U.S. Department of Energy's National Nuclear Security Administration under contract DE-NA0003525.

SAND No. SAND2019-2770 PE

2 Introduction



Sandia Critical Experiments Facility

- 7uPCX
- BUCCX

Titanium and Aluminum Sleeves

- Centering Pieces

Experimental Method

Results

- Critical Arrays
- Sleeve Reactivity Worth
- Uncertainty Analysis
- Benchmark Model
- Reactivity Offset

Conclusions

Acknowledgements

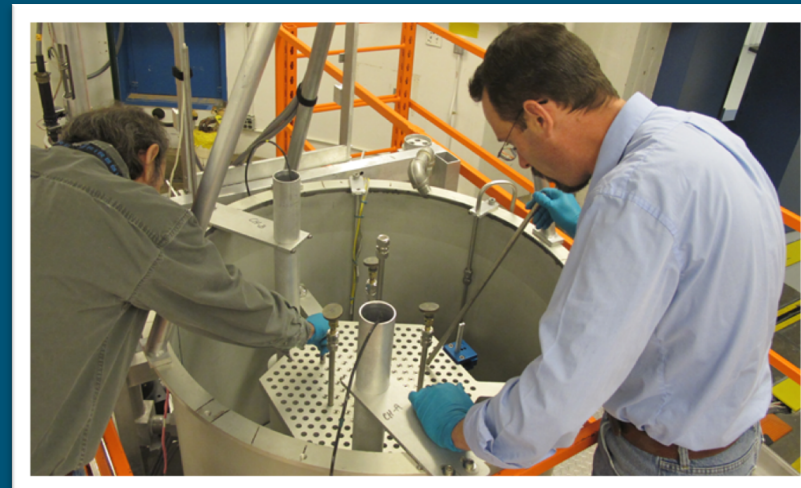
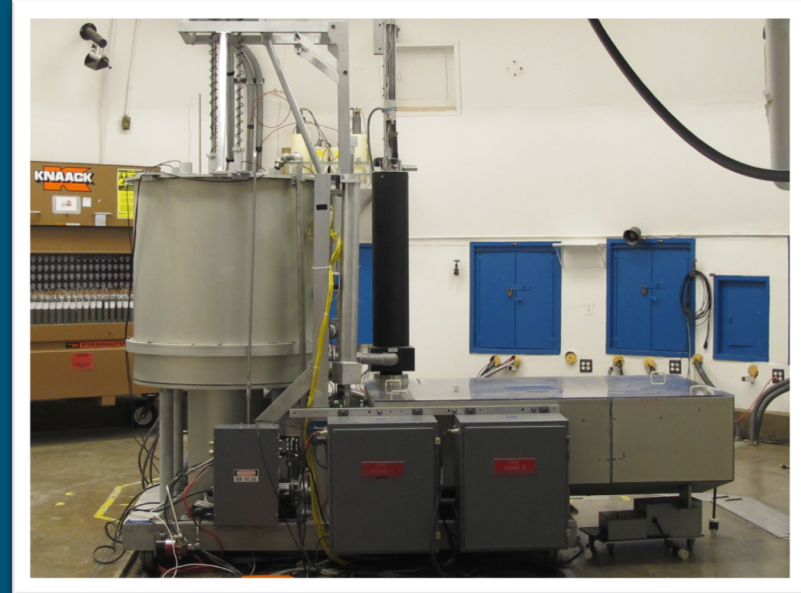



3 Sandia Critical Experiments Facility

The Seven Percent Critical Experiment (7uPCX)

- UO₂ fuel (6.9%)
- 45x45 Square array (pitch 0.315 and 0.337 inch)
- Fuel locations 2025
- Fuel rod diameter 0.25 inch
- Fuel length 19.25 inch
- LCT-078, 080, 096, 097

The Burnup Credit Critical Experiment (BUCCX)

- UO₂ fuel (4.3%)
- Triangular pitch (0.787 and 1.1 inch)
- Fuel locations 397 and 271
- Fuel rod diameter 0.544 inch
- Fuel length 19.37 inch
- LCT-079, 099

7uPCX

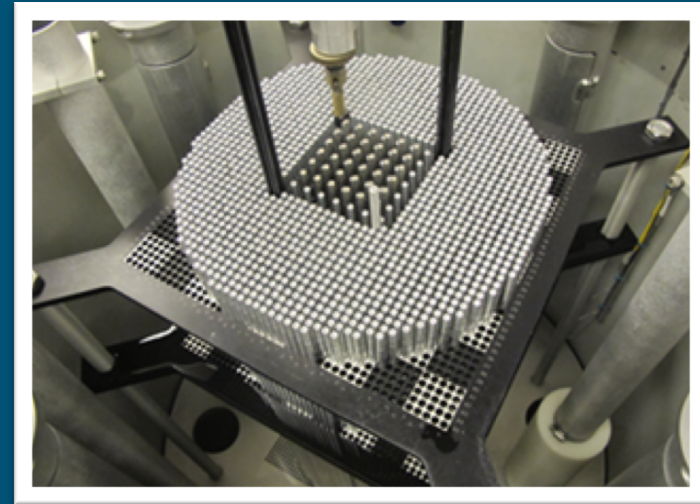

BUCCX

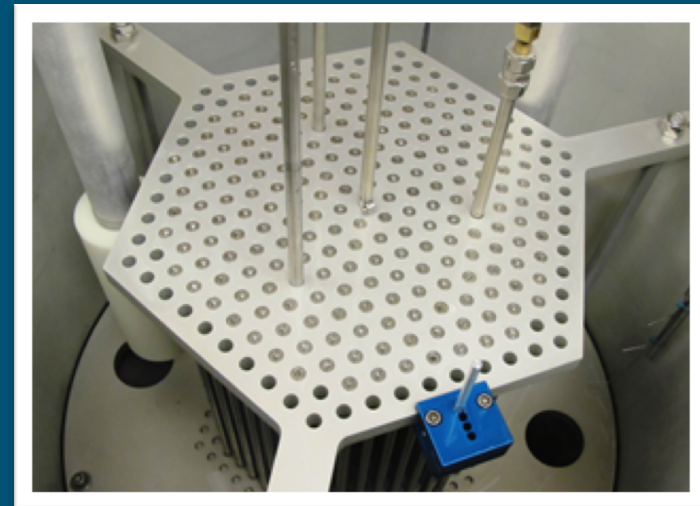

Critical Experiment	BUCCX		7uPCX	
Fuel	UO ₂		UO ₂	
Enrichment (%)	4.306		6.903	
Moderator	Light Water		Light Water	
Fuel OD (cm)	1.265		0.526	
Fuel Length (cm)	48.7		48.8	
Fuel Density (g/cm ³)	10.4		10.3	
Fuel Rod OD (cm)	1.382		0.635	
Array Configuration	Triangular Pitch		Square Pitch	
Pitch (cm)	2.0	2.8	0.800	0.855
Fuel to Water Volume Ratio	0.640	0.238	0.672	0.524
H to ²³⁵ U Atom Ratio	131	332	62.0	79.5
H to U Atom Ratio	4.48	12.1	4.33	5.55



4 Titanium and Aluminum Sleeves

Titanium sleeves

- Grade 2
- Outer diameter 1.0 inch
- Wall thickness 0.035 inch
- Length 19.6 inch
- Laser etched with ID number

Polyethylene Centering Pieces

- Length 0.85 inch
- O-rings hold in place

Sleeve ID number



Top and bottom centering pieces

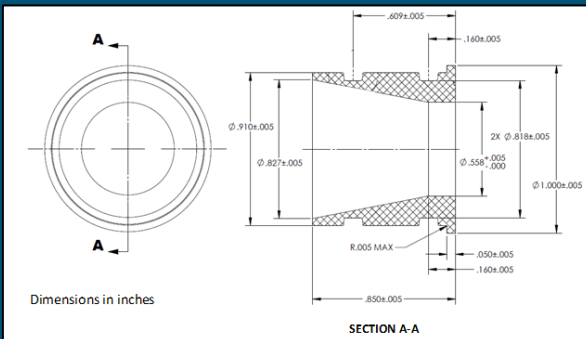

Top centering piece inserted



Sleeves ready to be placed in assembly

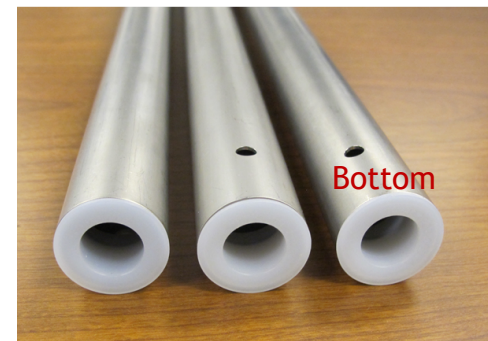
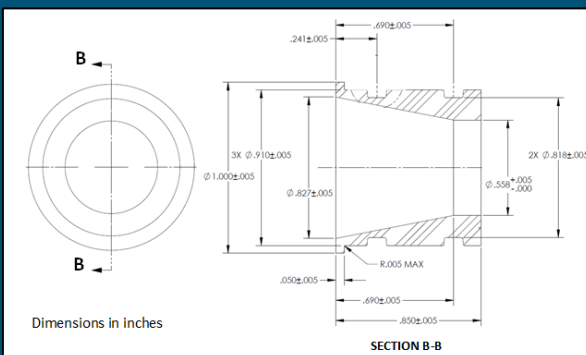



5 Titanium and Aluminum Sleeves

Sleeves are placed between the top and bottom grid plates (fueled section)

- Fuel element fed through top grid plate hole into the sleeve and into bottom grid plate hole
- Fuel element outer diameter 0.544 inch
- Sleeve inner diameter 0.93 inch

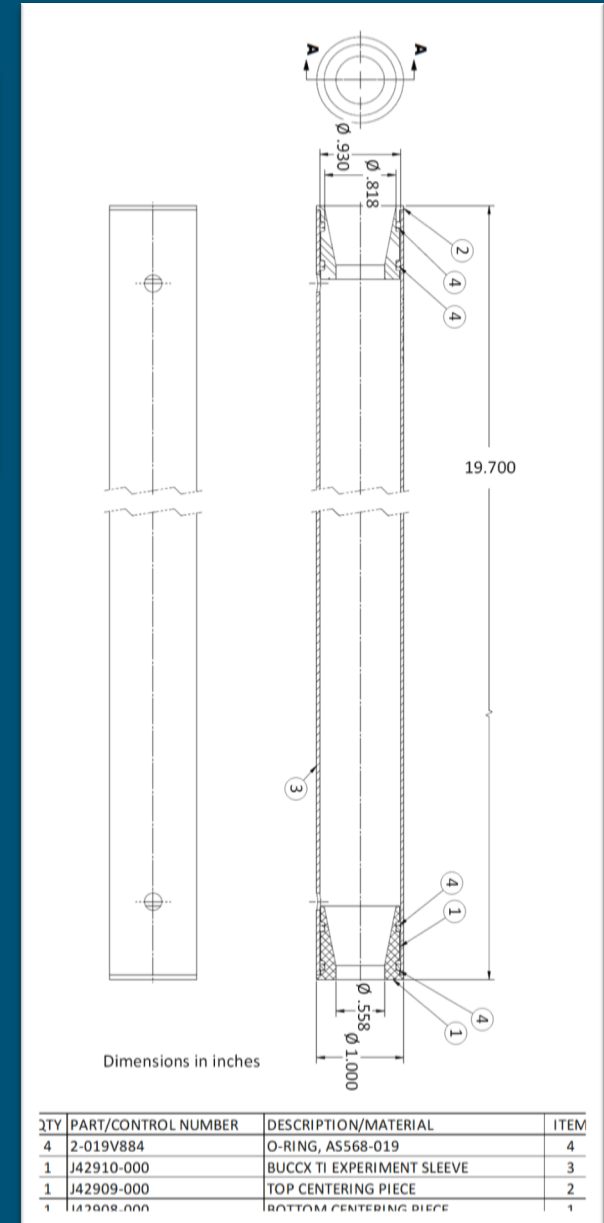
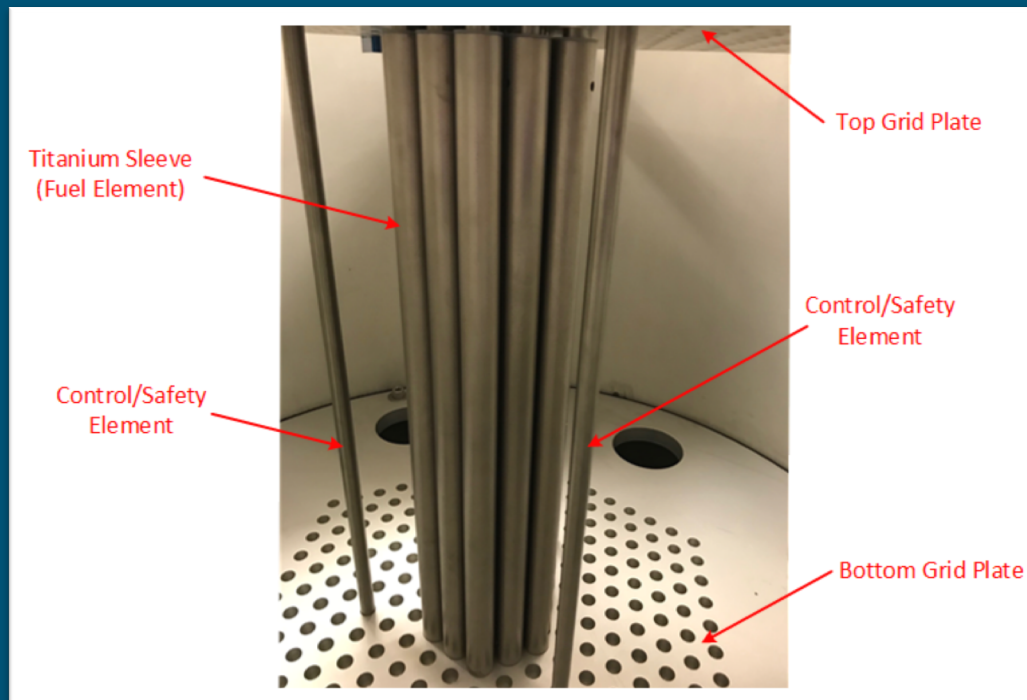
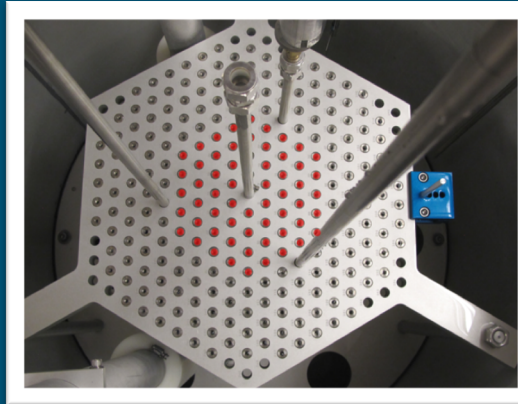

6 Experiment Method



Measure the effects of titanium and aluminum sleeves in the fuel array on the critical array size.

- All titanium experiments have corresponding aluminum experiments
 - Configuration of the sleeves (titanium and aluminum) the same for each case
 - Number of fuel rods in the array will differ due to the effects of titanium and aluminum

Critical array size for each configuration determined by an approach-to-critical experiment

- Array fully reflected by water
- Approach parameter is the number of fuel rods
 - Load from center toward the outside while maintaining a roughly cylindrical cross section of the array
 - Inverse count rate as function of number of fuel rods extrapolated to zero to obtain critical array size
- Initial two arrays for each configuration determined by calculations
 - 1st array: $k_{\text{eff}} = 0.90$
 - 2nd array: $k_{\text{eff}} = 0.95$
- Subsequent measurements guided by count rate results
 - Loading order guided by fuel element incremental worth calculations

17 critical experiments performed

- 1 with no sleeves
- 8 cases with titanium sleeves (varying quantities and configurations)
- 8 cases with aluminum sleeves (matching titanium cases)



7 Approach-to-Critical (case 2 and 10)

Approach-to-Critical (Case 2)

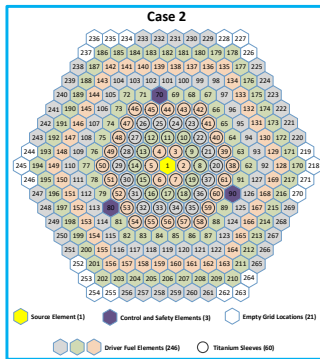
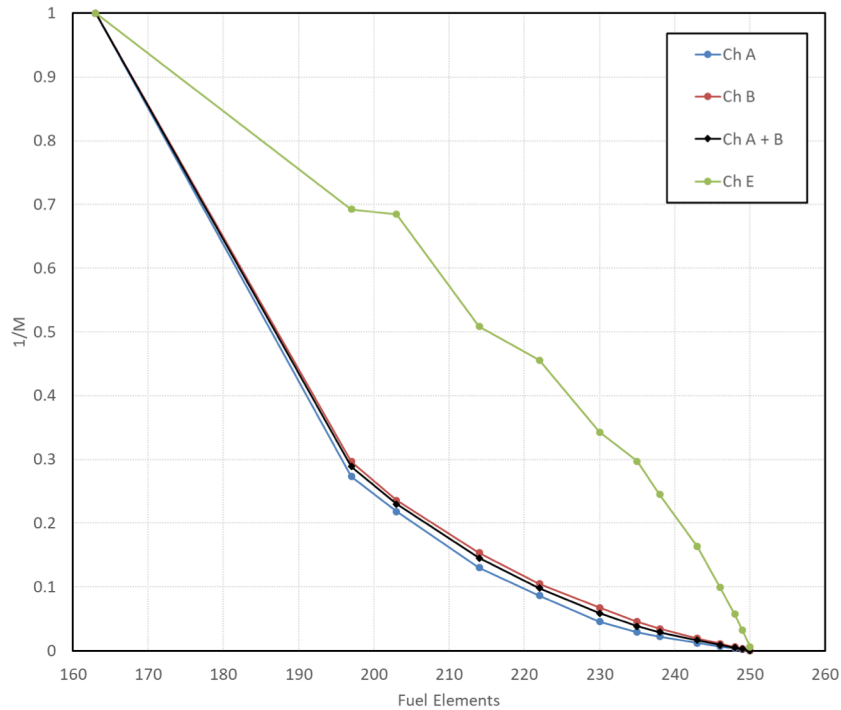

Fuel elements	Projection (A+B)	Uncertainty
163	-	-
197	210.7931	0.3524
203	226.4541	1.2581
214	232.8661	0.5437
222	238.6815	0.4697
230	241.8655	0.2289
235	244.5458	0.1571
238	247.5537	0.1218
243	249.2936	0.0355
246	249.8935	0.0167
248	250.2748	0.0068
249	250.1985	0.0027
250	250.2276	0.0002

Approach-to-Critical (Case 10)

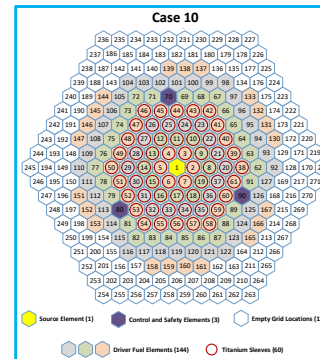
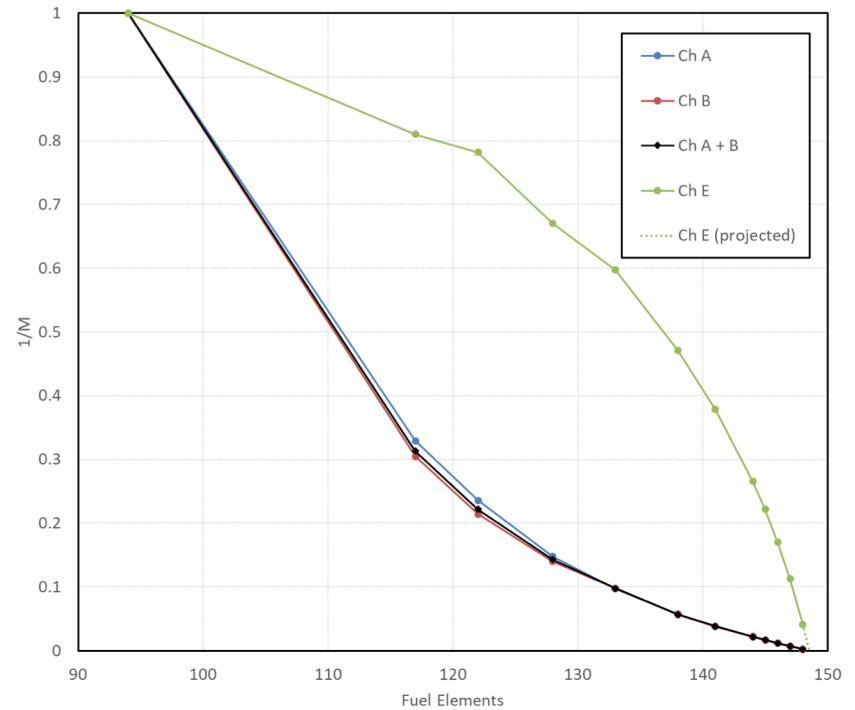

Fuel elements	Projection (A+B)	Uncertainty
94	-	-
117	127.4899	0.3654
122	134.0724	0.7031
128	138.8769	0.4713
133	143.7873	0.4024
138	145.0113	0.1653
141	147.0648	0.1404
144	148.0980	0.0500
145	148.3521	0.0537
146	148.2732	0.0235
147	148.4754	0.0093
148	148.4934	0.0013



8 Fuel Element Layout for Largest Array Measured (17 cases)

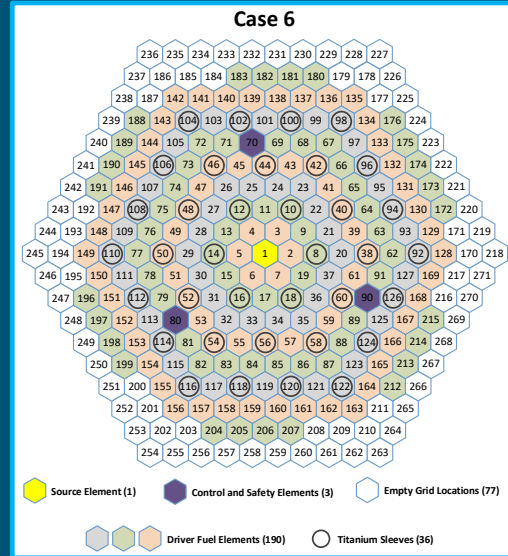
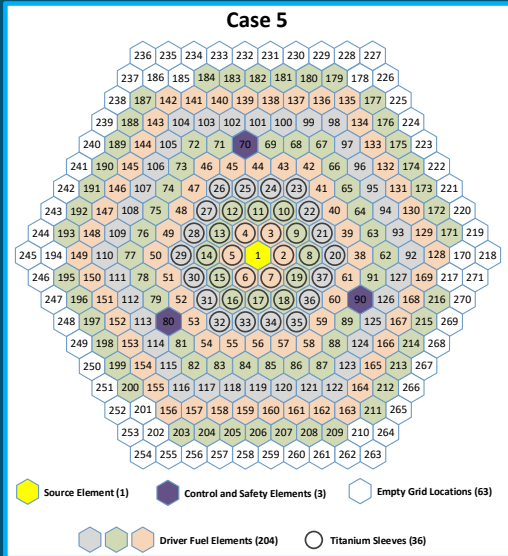
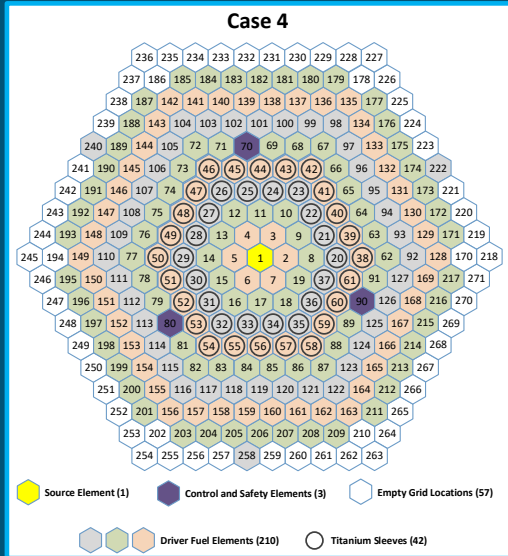
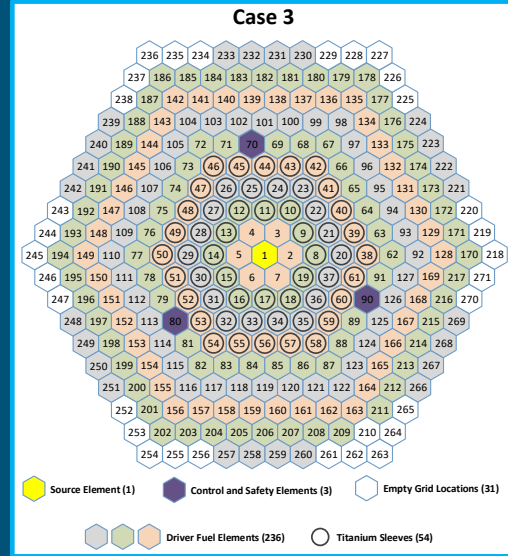
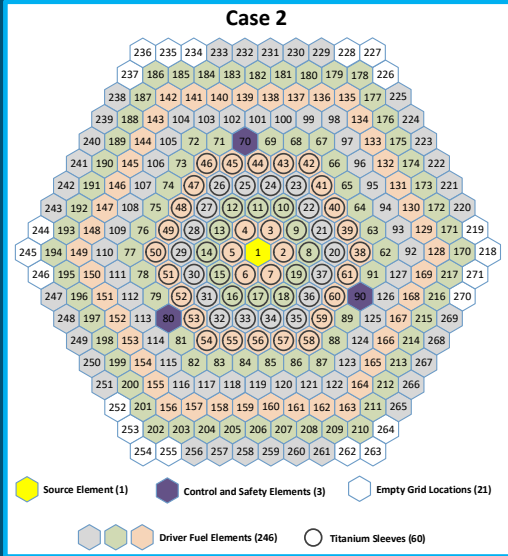
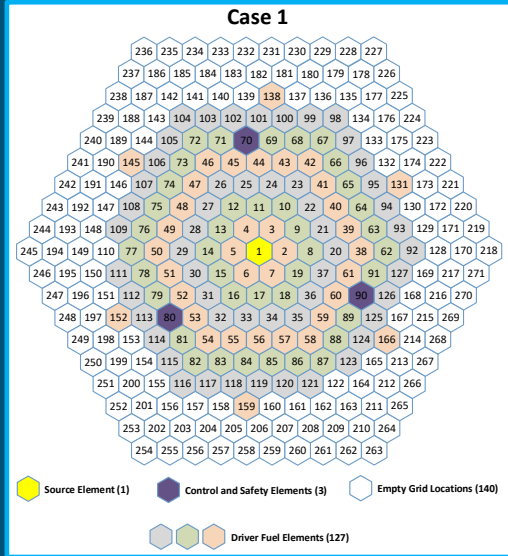



9 Fuel Element Layout for Largest Array Measured (17 cases)

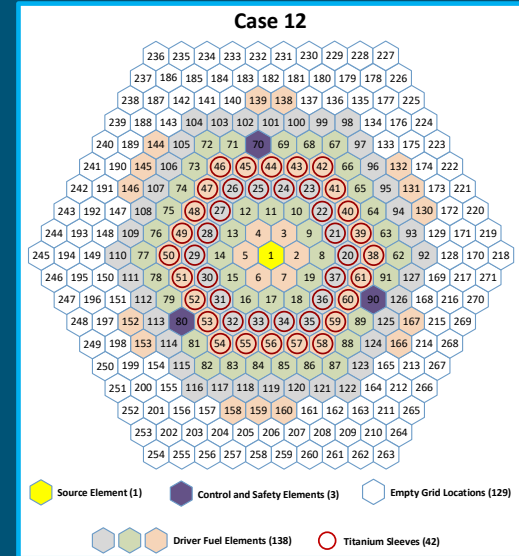
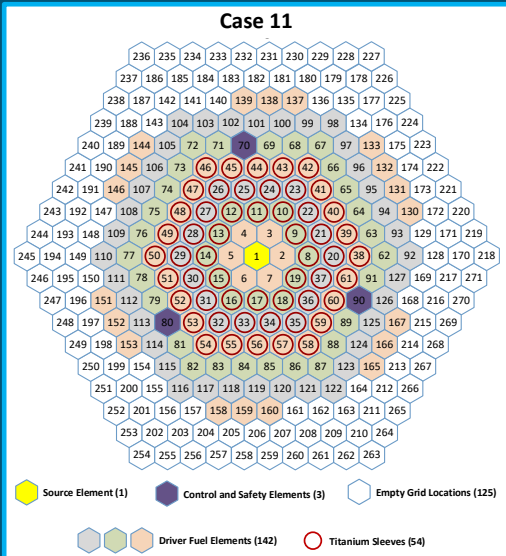
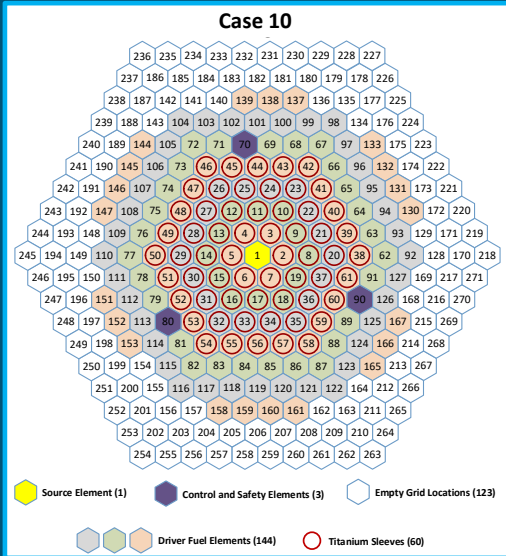
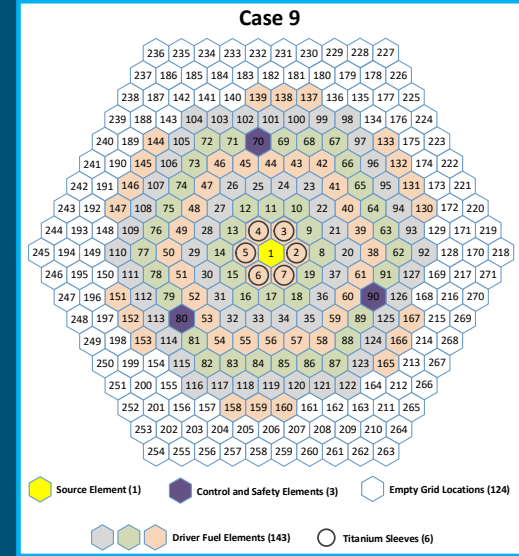
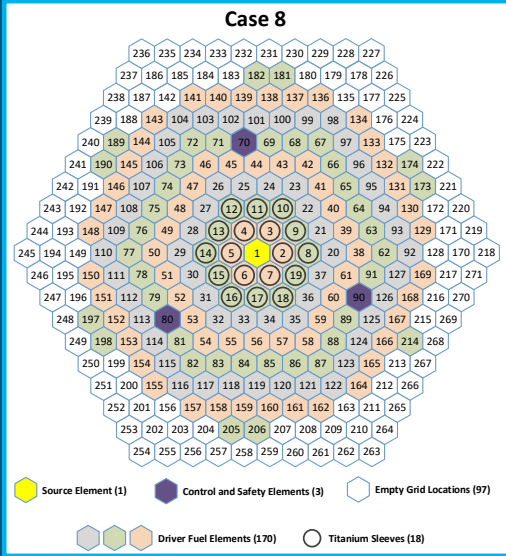
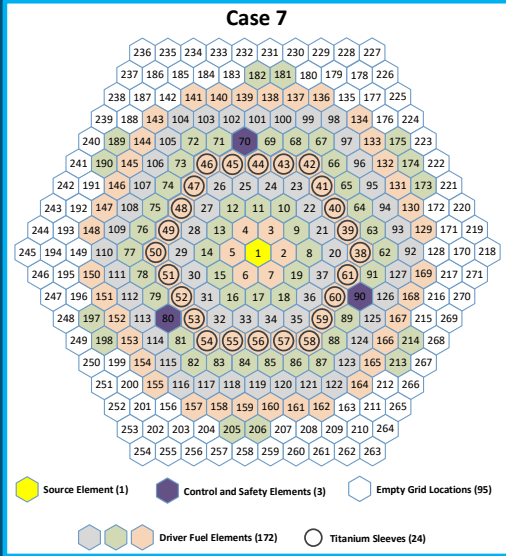

Fuel Element Layout for Largest Array Measured (17 cases)

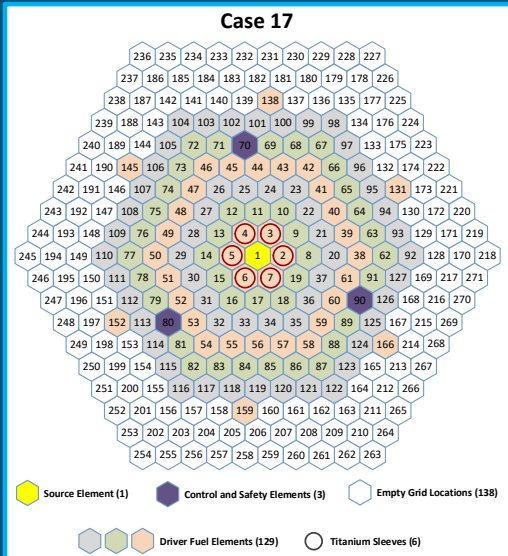
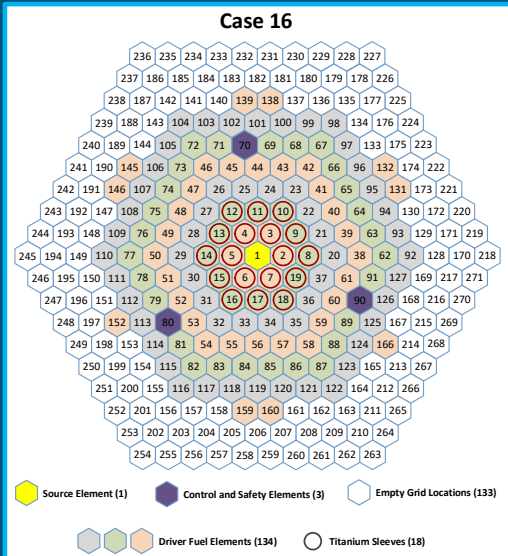
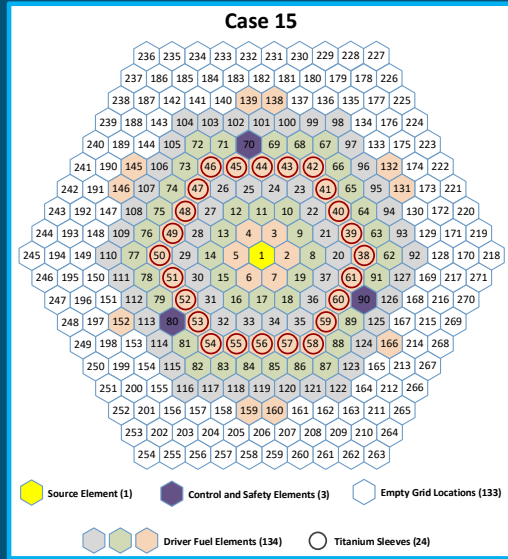
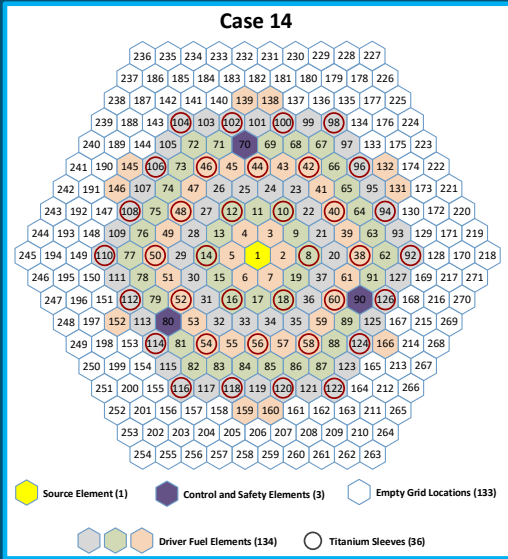
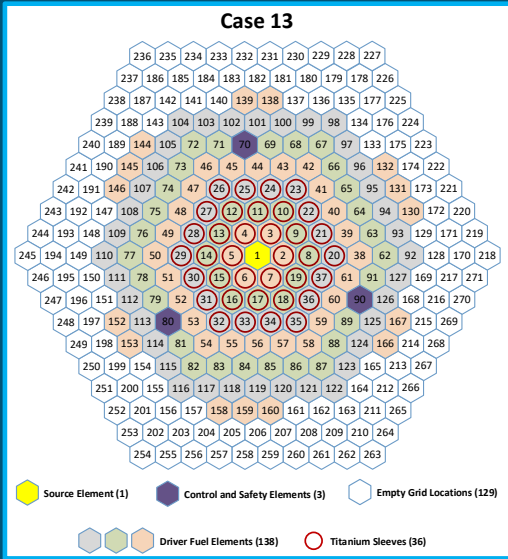

11 Core Analysis (Fission Density)



Case 1 (no sleeves)

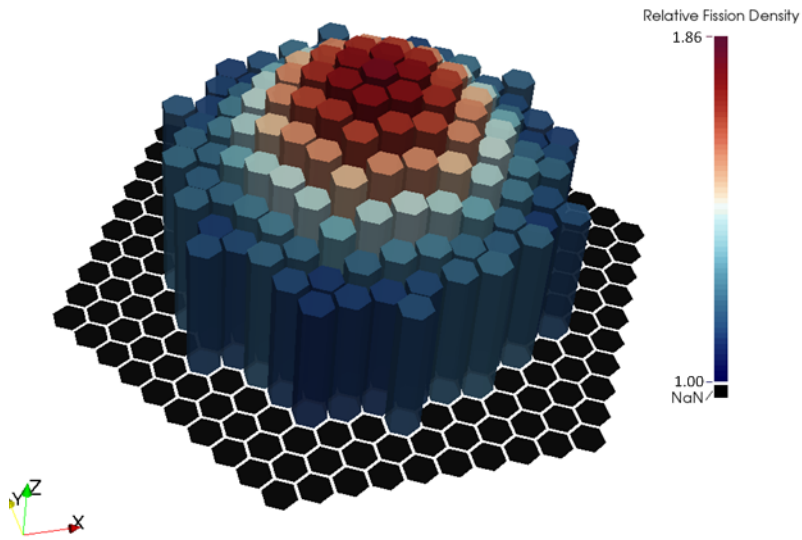
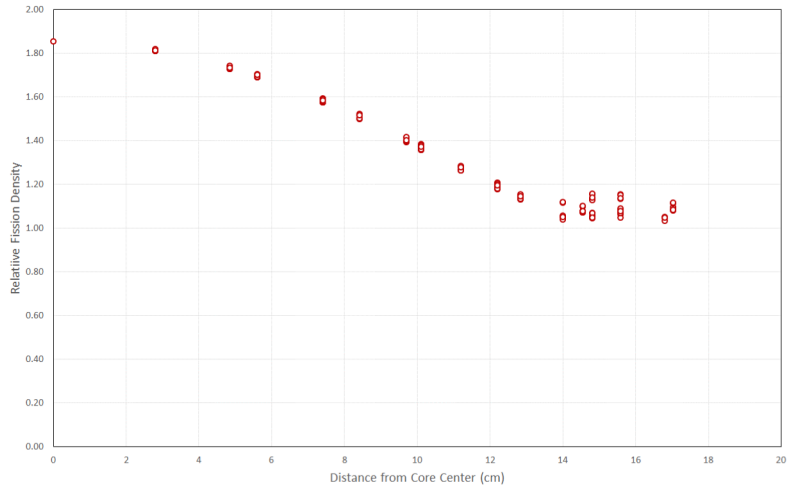

Case 2 (60 titanium sleeves)

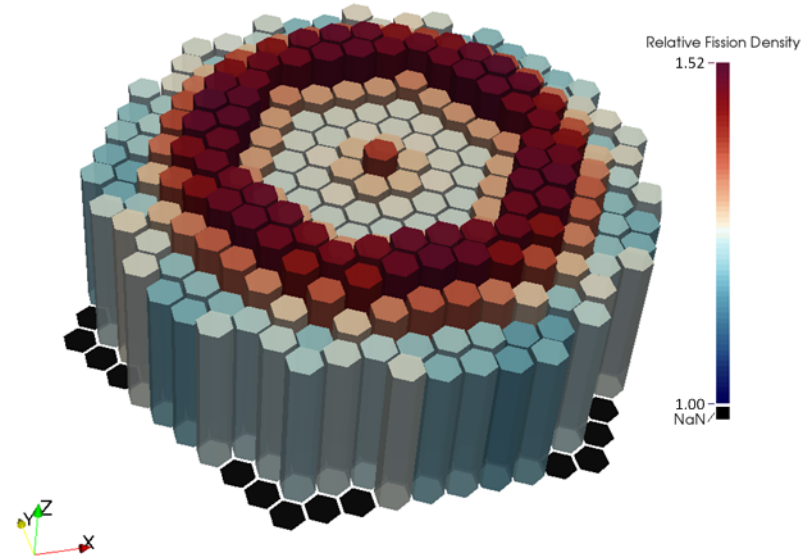
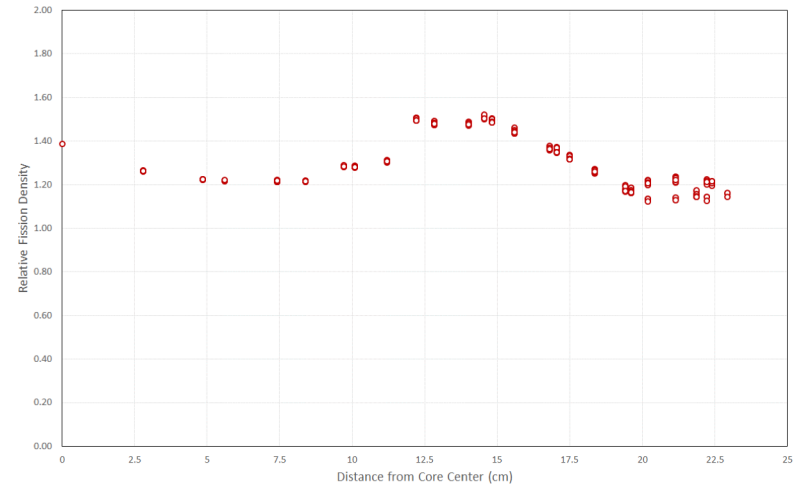

Titanium and Aluminum Sleeve Reactivity Worth



Case	Number of Experiment Sleeves		Experiment Sleeve Reactivity Worth (%)
	Titanium	Aluminum	
1	0	0	0
2	60	0	-9.57 ± 0.01
3	54	0	-9.07 ± 0.01
4	42	0	-7.67 ± 0.01
5	36	0	-7.23 ± 0.01
6	36	0	-6.23 ± 0.01
7	24	0	-4.84 ± 0.01
8	18	0	-4.67 ± 0.01
9	6	0	-2.07 ± 0.01
10	0	60	-0.31 ± 0.01
11	0	54	-0.23 ± 0.01
12	0	42	-0.13 ± 0.01
13	0	36	-0.24 ± 0.01
14	0	36	-0.02 ± 0.01
15	0	24	-0.06 ± 0.01
16	0	18	-0.15 ± 0.01
17	0	6	-0.06 ± 0.01

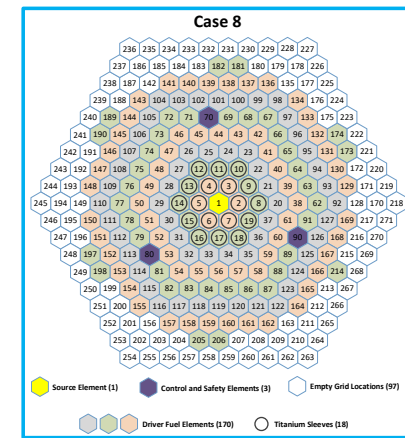
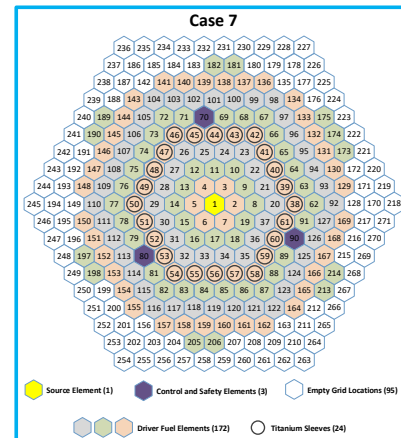
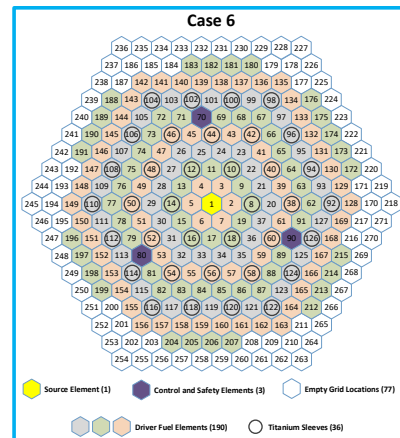
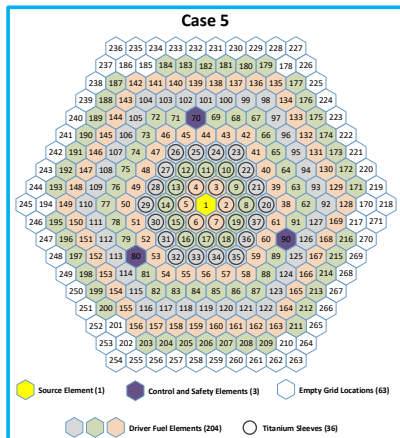
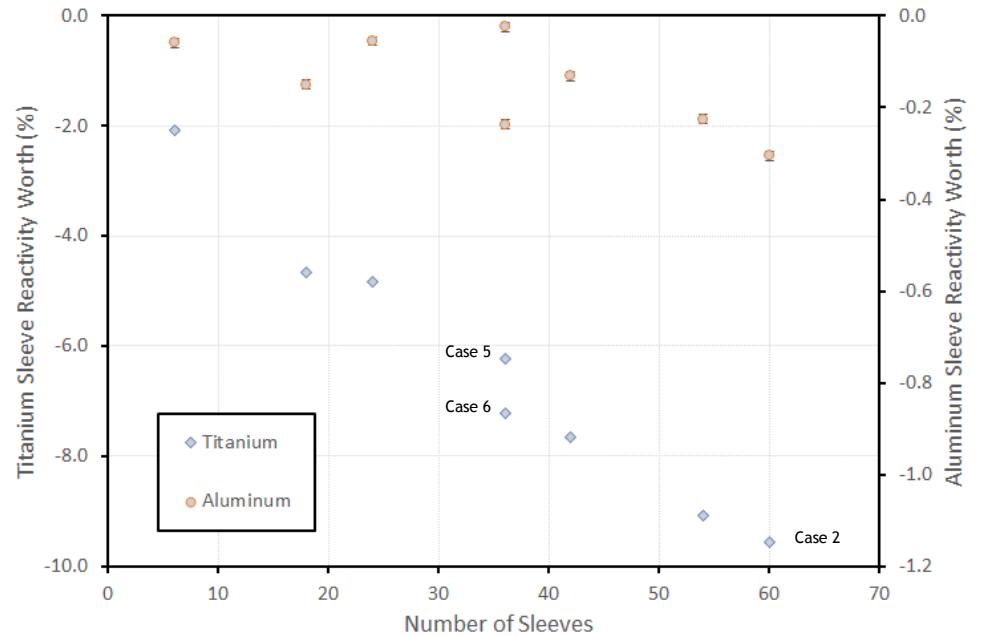



Detailed records kept of location and identity of each fuel element in each core

- Fuel elements placed in same grid location in each core

Critical array size extrapolated from largest measured subcritical array

- Most measured cases within a fraction of a single element from delayed critical
- Uncertainties in count rate propagated through the extrapolation

Case	Largest Subcritical Array Measured			Extrapolated Critical Array Size (Elements)	Nearest Integral Array Size (Elements)	Experiment Temperature (°C)
	Number of Fuel Elements	Number of Driver Fuel Elements ^(a)	Driver Element UO ₂ Mass (g)			
1	131	127	81127.50	131.877 ± 0.004	132	25.1
2	250	246	156832.50	250.228 ± 0.000	250	25.0
3	240	236	150400.00	240.296 ± 0.000	240	25.1
4	214	210	133721.00	215.098 ± 0.003	215	24.9
5	208	204	129868.50	209.016 ± 0.003	209	24.8
6	194	190	120915.50	194.502 ± 0.001	195	24.7
7	176	172	109586.00	177.050 ± 0.004	177	24.6
8	174	170	108327.00	174.741 ± 0.002	175	24.8
9	147	143	91273.00	148.088 ± 0.006	148	24.6
10	148	144	91912.50	148.493 ± 0.001	148	25.0
11	146	142	90634.50	146.560 ± 0.002	147	24.5
12	142	138	88096.00	142.565 ± 0.002	143	25.0
13	142	138	88096.00	142.889 ± 0.004	143	24.7
14	137	133	84920.50	137.960 ± 0.005	138	25.1
15	137	133	84920.50	137.283 ± 0.001	137	25.4
16	137	133	84920.50	137.714 ± 0.003	138	24.6
17	133	129	82390.00	133.952 ± 0.005	134	24.7

(a) All cores include a source element and three control/safety elements.



Analyses performed with MCNP6.2 using Continuous-energy cross sections from ENDF/B-VII.1

- Direct Perturbations
 - Least-squares fit with uncertainty propagation
- Sensitives to materials (KSEN)
 - Combined to assess uncertainties
- Temperature (makssf)
 - Thermal expansion of fuel, density of water, Doppler broadening, thermal scattering

Case 1: No Sleeves

Uncertainty Source	Type	Uncertainty Value	Sensitivity		Δk_{eff}
			Value	Unc.	
Pitch of Fuel Elements (cm)	B	0.00239	0.0264	0.00025	0.00006
Clad OD (cm)	A	0.000106	-0.08200	0.00023	-0.00001
Clad Thickness (cm)	B	0.00293	0.03867	0.00023	0.00011
Fuel OD (cm)	A	0.0025	0.02157	0.00015	0.00005
Upper Reflector (mm)	A	2	0.000002	0.000001	0.00000
Element Fuel Mass (cm)	A	0.011	0.00223	0.00002	0.00002
Fuel Enrichment (mass fraction)	A	0.00013	4.7751	0.0014	0.00062
²³⁴ U (mass fraction)	A	0.00002	-4.0658	0.0082	-0.00008
²³⁶ U (mass fraction)	A	0.00002	-0.9441	0.0076	-0.00002
UO ₂ Stoichiometry (U mass fraction)	A	0.00261	0.06668	0.00077	0.00017
Clad Composition	B	Details within report			0.00008
Grid Plate Composition	B				0.00003
Water Composition	A				0.00024
Temperature (K)	A	1	0.000042	0.000003	0.00004
Sum in Quadrature					0.00071



Analyses performed with MCNP6.2 using Continuous-energy cross sections from ENDF/B-VII.1

- Direct Perturbations
 - Least-squares fit with uncertainty propagation
- Sensitives to materials (KSEN)
 - Combined to assess uncertainties
- Temperature (makssf)
 - Thermal expansion of fuel, density of water, Doppler broadening, thermal scattering

Case 2: 60 Titanium Sleeves

Uncertainty Source	Type	Uncertainty Value	Sensitivity		Δk_{eff}
			Value	Unc.	
Pitch of Fuel Elements (cm)	B	0.00239	-0.0100	0.00019	-0.00002
Clad OD (cm)	A	0.000106	-0.04187	0.00023	0.00000
Clad Thickness (cm)	B	0.00293	0.01080	0.00017	0.00003
Fuel OD (cm)	A	0.0025	0.03139	0.00015	0.00008
Upper Reflector (mm)	A	2	0.000002	0.000001	0.00000
Element Fuel Mass (cm)	A	0.01	0.00268	0.00002	0.00003
Experiment Sleeve OD (cm)	A	0.00019	-0.0118	0.0001	0.00000
Experiment Sleeve ID (cm)	B	0.00020	0.3434	0.0001	0.00007
Fuel Enrichment (mass fraction)	A	0.00013	5.4569	0.0016	0.00071
²³⁴ U (mass fraction)	A	0.00002	-4.0470	0.0082	-0.00008
²³⁶ U (mass fraction)	A	0.00002	-0.9957	0.0078	-0.00002
UO ₂ Stoichiometry (U mass fraction)	A	0.00261	0.12909	0.00075	0.00034
Clad Composition	B	Details within report			0.00009
Grid Plate Composition	B				0.00003
Experiment Sleeve Composition	A				0.00001
Water Composition	A				0.00019
Temperature (K)	A	1	0.000069	0.000003	0.00007
Sum in Quadrature					0.00083



Analyses performed with MCNP6.2 using Continuous-energy cross sections from ENDF/B-VII.1

- Direct Perturbations
 - Least-squares fit with uncertainty propagation
- Sensitives to materials (KSEN)
 - Combined to assess uncertainties
- Temperature (makssf)
 - Thermal expansion of fuel, density of water, Doppler broadening, thermal scattering

Case 10: 60 Aluminum Sleeves

Uncertainty Source	Type	Uncertainty Value	Sensitivity		Δk_{eff}
			Value	Unc.	
Pitch of Fuel Elements (cm)	B	0.00239	0.0590	0.0003	0.00014
Clad OD (cm)	A	0.000106	-0.09467	0.00023	-0.00001
Clad Thickness (cm)	B	0.00293	0.04067	0.00023	0.00012
Fuel OD (cm)	A	0.0025	0.01896	0.00015	0.00005
Upper Reflector (mm)	A	2	0.000002	0.000001	0.00000
Element Fuel Mass (cm)	A	0.01	0.00240	0.00002	0.00003
Experiment Sleeve OD (cm)	A	0.00019	-0.1220	0.0001	-0.00002
Experiment Sleeve ID (cm)	B	0.00020	0.1273	0.0001	0.00003
Fuel Enrichment (mass fraction)	A	0.00013	4.7135	0.0019	0.00061
²³⁴ U (mass fraction)	A	0.00002	-4.2092	0.0090	-0.00008
²³⁶ U (mass fraction)	A	0.00002	-1.0083	0.0073	-0.00002
UO ₂ Stoichiometry (U mass fraction)	A	0.00261	0.05977	0.00079	0.00016
Clad Composition	B	Details within report			0.00009
Grid Plate Composition	B				0.00003
Experiment Sleeve Composition	A				0.00005
Water Composition	A				0.00022
Temperature (K)	A	1	0.000030	0.000003	0.00003
Sum in Quadrature					0.00071



Fuel Element

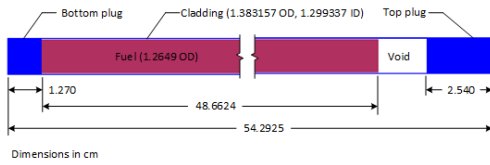

Fuel Element with Titanium Sleeve

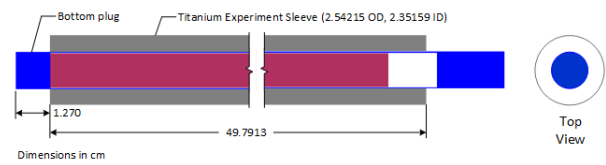

Detector Dry Well

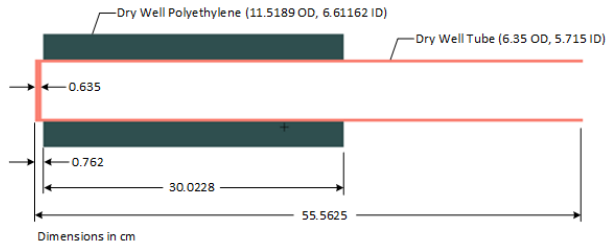

Fuel Element with Aluminum Sleeve



Top View Layout

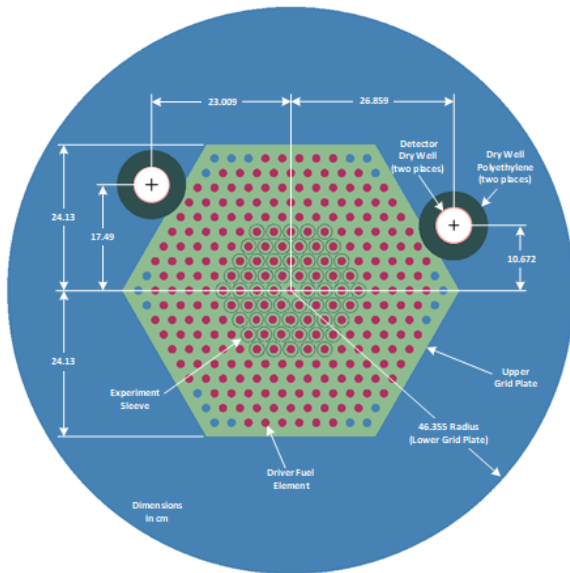

Cut-Away Core

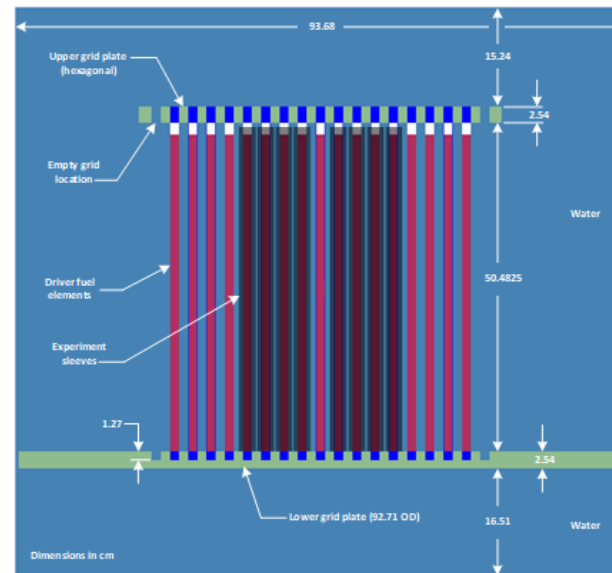



Analyses performed with MCNP6.2 using Continuous-energy cross sections from ENDF/B-VII.1

- Simplifications
- Temperature corrections
- Fractional fuel elements
- Overall reactivity bias

Simplification Bias

Case	Simplified Model Bias	Uncertainty in the Bias
1	-0.00001	0.00001
2	-0.00012	0.00001
3	0.00009	0.00001
4	-0.00026	0.00001
5	0.00003	0.00001
6	0.00000	0.00001
7	-0.00006	0.00001
8	0.00024	0.00001
9	-0.00033	0.00001
10	-0.00015	0.00001
11	-0.00015	0.00001
12	-0.00011	0.00001
13	-0.00011	0.00001
14	-0.00006	0.00001
15	-0.00004	0.00001
16	-0.00008	0.00001
17	-0.00004	0.00001

Temperature and Fraction Fuel Element Bias

Case	Temperature-Corrected Critical Array Size N_C		Model Array Size	Incremental Fuel Element Sensitivity S_V		Reactivity Bias	
	Value	Unc.		Value	Unc.	Value	Unc.
1	131.879	0.004	132	0.00151	0.00001	0.000183	0.000006
2	250.230	0.000	250	0.00100	0.00001	-0.000230	0.000003
3	240.303	0.001	240	0.00098	0.00001	-0.000297	0.000004
4	215.091	0.003	215	0.00109	0.00001	-0.000099	0.000004
5	209.006	0.003	209	0.00104	0.00001	-0.000006	0.000003
6	194.484	0.001	195	0.00105	0.00001	0.000541	0.000007
7	177.031	0.004	177	0.00110	0.00001	-0.000034	0.000004
8	174.732	0.002	175	0.00115	0.00001	0.000308	0.000005
9	148.076	0.006	148	0.00151	0.00001	-0.000115	0.000009
10	148.493	0.001	148	0.00154	0.00001	-0.000758	0.000007
11	146.550	0.002	147	0.00153	0.00001	0.000689	0.000007
12	142.566	0.002	143	0.00143	0.00001	0.000620	0.000007
13	142.881	0.004	143	0.00146	0.00001	0.000174	0.000006
14	137.962	0.004	138	0.00150	0.00001	0.000058	0.000007
15	137.292	0.001	137	0.00151	0.00001	-0.000441	0.000004
16	137.702	0.003	138	0.00152	0.00001	0.000453	0.000006
17	133.943	0.005	134	0.00155	0.00001	0.000088	0.000008

Overall Bias

Case	Simplification Bias		Integral Fuel Element Bias		Overall Bias	
	Bias	Uncertainty	Bias	Uncertainty	Bias	Uncertainty
1	-0.00001	0.00001	0.000183	0.000006	0.00017	0.00002
2	-0.00012	0.00001	-0.000230	0.000003	-0.00035	0.00001
3	0.00009	0.00001	-0.000297	0.000004	-0.00021	0.00001
4	-0.00026	0.00001	-0.000099	0.000004	-0.00036	0.00001
5	0.00003	0.00001	-0.000006	0.000003	0.00002	0.00001
6	0.00000	0.00001	0.000541	0.000007	0.00054	0.00002
7	-0.00006	0.00001	-0.000034	0.000004	-0.00009	0.00001
8	0.00024	0.00001	0.000308	0.000005	0.00055	0.00001
9	-0.00033	0.00001	-0.000115	0.000009	-0.00045	0.00002
10	-0.00015	0.00001	-0.000758	0.000007	-0.00091	0.00002
11	-0.00015	0.00001	0.000689	0.000007	0.00054	0.00002
12	-0.00011	0.00001	0.000620	0.000007	0.00051	0.00002
13	-0.00011	0.00001	0.000174	0.000006	0.00006	0.00002
14	-0.00006	0.00001	0.000058	0.000007	0.00000	0.00002
15	-0.00004	0.00001	-0.000441	0.000004	-0.00048	0.00001
16	-0.00008	0.00001	0.000453	0.000006	0.00037	0.00002
17	-0.00004	0.00001	0.000088	0.000008	0.00005	0.00002

Benchmark Model k_{eff}

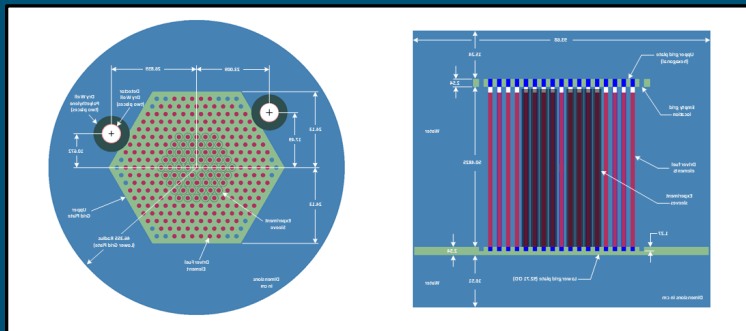
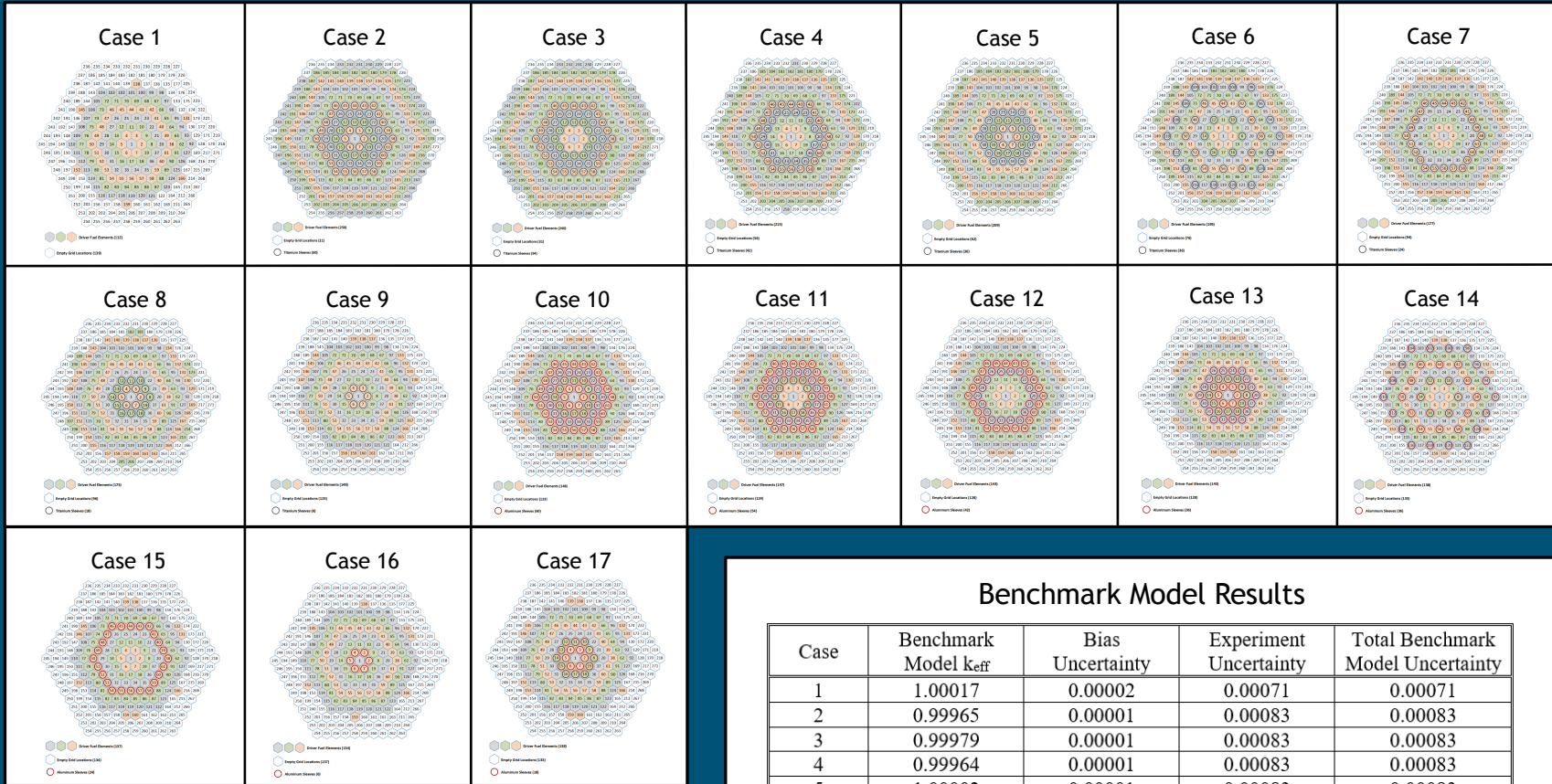

Benchmark Model Results

Case	Benchmark Model k_{eff}	Bias Uncertainty	Experiment Uncertainty	Total Benchmark Model Uncertainty
1	1.00017	0.00002	0.00071	0.00071
2	0.99965	0.00001	0.00083	0.00083
3	0.99979	0.00001	0.00083	0.00083
4	0.99964	0.00001	0.00083	0.00083
5	1.00002	0.00001	0.00083	0.00083
6	1.00054	0.00002	0.00083	0.00083
7	0.99991	0.00001	0.00083	0.00083
8	1.00055	0.00001	0.00083	0.00083
9	0.99955	0.00002	0.00083	0.00083
10	0.99909	0.00002	0.00071	0.00071
11	1.00054	0.00002	0.00071	0.00071
12	1.00051	0.00002	0.00071	0.00071
13	1.00006	0.00002	0.00071	0.00071
14	1.00000	0.00002	0.00071	0.00071
15	0.99952	0.00001	0.00071	0.00071
16	1.00037	0.00002	0.00071	0.00071
17	1.00005	0.00002	0.00071	0.00071

Results of Sample Calculations

$$\rho = \frac{k_c - k_b}{k_c \cdot k_b}$$

ρ = reactivity offset

k_c = calculated k_{eff}

k_b = evaluated benchmark k_{eff}

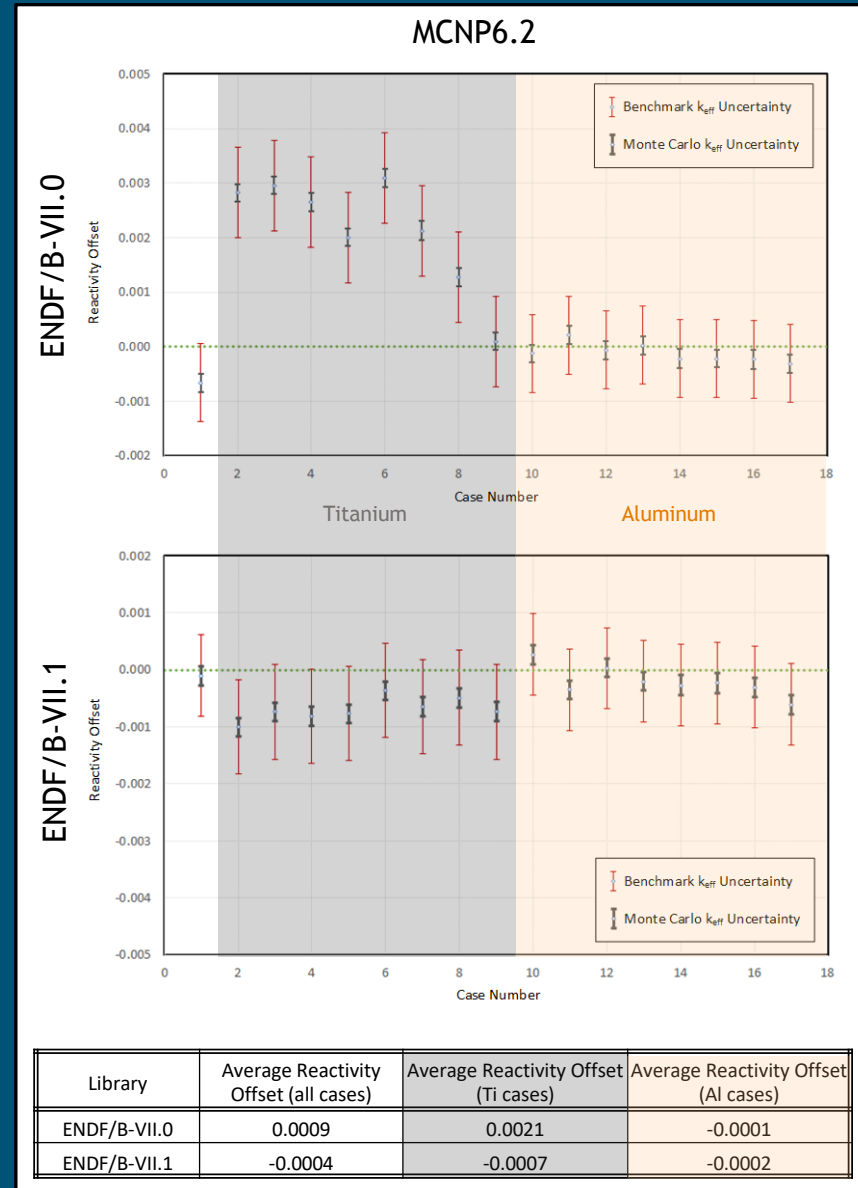
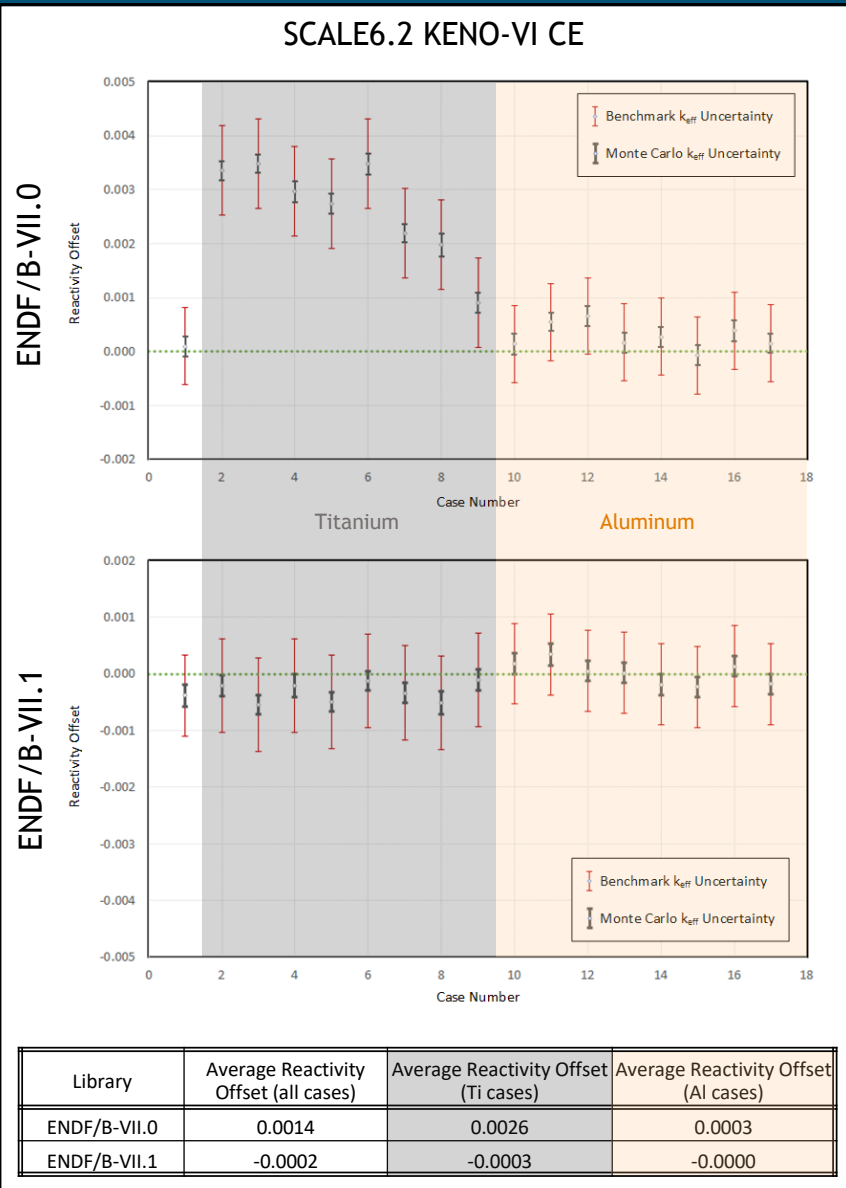



- Second set of titanium experiments now complete.
 - First set LCT-097 for titanium rods in 7uPCX
- To be included as LCT-099 in 2019 ICSBEP Handbook

Acknowledgements

The critical experiments performed at Sandia are supported by the DOE Nuclear Criticality Safety Program. Sandia National Laboratories is a multi-program laboratory managed and operated by National Technology and Engineering Solutions of Sandia, a wholly owned subsidiary of Honeywell International, for the U.S. Department of Energy's National Security Administration.

